

10MHz, Low Noise, Operational Amplifiers

The HA-5101 is a dielectrically isolated operational amplifier featuring low noise, (3.0nV/√Hz at 1kHz).

DC characteristics of the HA-5101 assure accurate performance. The 0.5mV offset voltage is externally adjustable and offset voltage drift is just 3μV/°C. An offset current of only 30nA reduces input current errors and an open loop voltage gain of 1 x 10⁶V/V increases loop gain for low distortion amplification.

The HA-5101 is ideal for audio applications, especially low-level signal amplifiers such as microphone, tape head and phono cartridge preamplifiers. Additionally, it is well suited for low distortion oscillators, low noise function generators and high Q filters.

Pinout

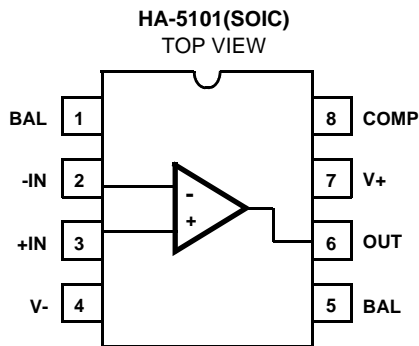

Features

- Low Noise 3.0nV/√Hz at 1kHz
- Bandwidth 10MHz
- Slew Rate 10V/μs
- Low Offset Voltage Drift 3μV/°C
- High Gain 1 x 10⁶V/V
- High CMRR/PSRR 100dB
- High Output Drive Capability 30mA

Applications

- High Quality Audio Preamplifiers
- High Q Active Filters
- Low Noise Function Generators
- Low Distortion Oscillators
- Low Noise Comparators
- For Further Design Ideas, See Application Note AN554

Part Number Information

PART NUMBER (BRAND)	TEMP. RANGE (°C)	PACKAGE	PKG. NO.
HA9P5101-9 (H51019)	-40 to 85	8 Ld SOIC	M8.15

Schematic

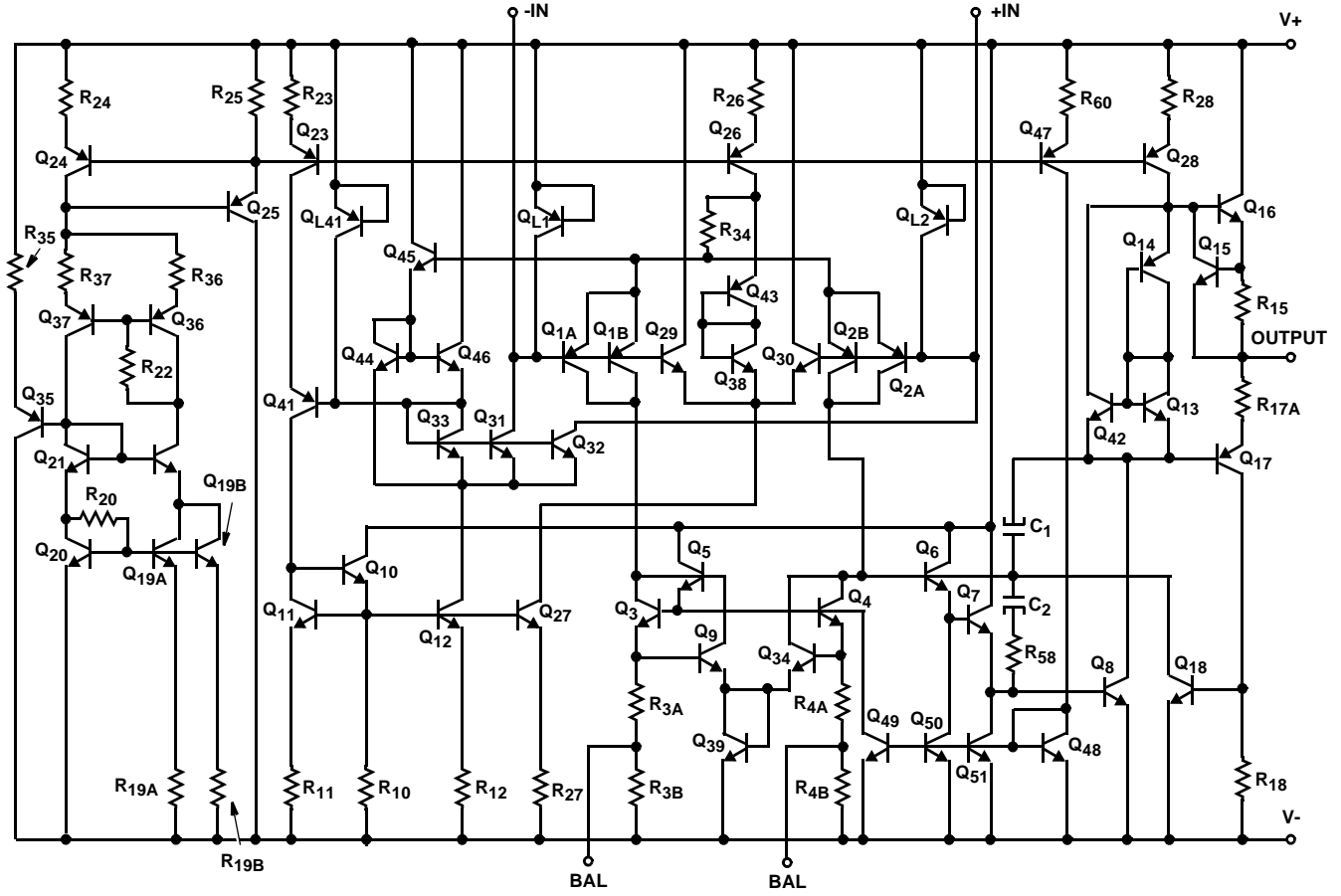

Absolute Maximum Ratings

Voltage Between V+ and V- Terminals 40V
 Differential Input Voltage 7V
 Input Voltage $\pm V_{SUPPLY}$
 Output Current Full Short Circuit Protection

Thermal Information

Thermal Resistance (Typical, Note 2) θ_{JA} (°C/W) θ_{JC} (°C/W)
 SOIC Package 160 N/A
 Maximum Junction Temperature (Note 1) 150°C
 Maximum Storage Temperature Range -65°C to 150°C
 Maximum Lead Temperature (Soldering 10s) 300°C
 (Lead Tips Only)

Operating Conditions

Temperature Range
 HA-5101-9 -40°C to 85°C

CAUTION: Stresses above those listed in "Absolute Maximum Ratings" may cause permanent damage to the device. This is a stress only rating and operation of the device at these or any other conditions above those indicated in the operational sections of this specification is not implied.

NOTES:

1. Maximum power dissipation, including output load, must be designed to maintain the maximum junction temperature below 150°C for the plastic packages.
2. θ_{JA} is measured with the component mounted on a low effective thermal conductivity test board in free air. See Tech Brief TB379 for details.

Electrical Specifications $V_{SUPPLY} = \pm 15V, R_S = 100\Omega, R_L = 2k\Omega, C_L = 50pF$, Unless Otherwise Specified

PARAMETER	TEST CONDITIONS	TEMP (°C)	MIN	TYP	MAX	UNITS
INPUT CHARACTERISTICS						
Offset Voltage		25	-	0.5	3	mV
		Full	-	-	4	mV
Offset Voltage Drift		Full	-	3	-	$\mu V/^\circ C$
Bias Current		25	-	100	200	nA
		Full	-	-	325	nA
Offset Current		25	-	30	75	nA
		Full	-	-	125	nA
Input Resistance		25	-	500	-	k Ω
Common Mode Range		Full	± 12	-	-	V
TRANSFER CHARACTERISTICS						
Large Signal Voltage Gain	$V_{OUT} = \pm 10V$	25	-	1000	-	kV/V
		Full	100	250	-	kV/V
Common Mode Rejection Ratio	$V_{CM} = \pm 10V$	Full	80	100	-	dB
Small Signal Bandwidth	$A_V = 1$	25	-	10	-	MHz
Minimum Stable Gain		Full	1	-	-	V/V
OUTPUT CHARACTERISTICS						
Output Voltage Swing	$R_L = 10k\Omega$	Full	± 12	± 13	-	V
	$R_L = 2k\Omega$	Full	± 12	± 13	-	V
	$V_S = \pm 18V, R_L = 600\Omega$	25	± 15	-	-	V
Output Current (Note 3)		25	25	30	-	mA
Full Power Bandwidth (Note 4)		25	95	160	-	kHz
Output Resistance		25	-	110	-	Ω
Maximum Load Capacitance		25	-	800	-	pF
TRANSIENT RESPONSE (Note 5)						
Rise Time		25	-	50	100	ns
Overshoot		25	-	20	35	%

Electrical Specifications $V_{SUPPLY} = \pm 15V$, $R_S = 100\Omega$, $R_L = 2k\Omega$, $C_L = 50pF$, Unless Otherwise Specified (Continued)

PARAMETER	TEST CONDITIONS	TEMP (°C)	MIN	TYP	MAX	UNITS
Slew Rate		25	6	10	-	V/ μ s
Settling Time (Note 6)	0.01%	-	-	2.6	-	μ s
NOISE CHARACTERISTICS (Note 7)						
Input Noise Voltage	f = 10Hz	25	-	5	7	nV/ \sqrt{Hz}
	f = 1kHz	25	-	3.0	4.0	nV/ \sqrt{Hz}
Input Noise Current	f = 10Hz	25	-	4.0	9	pA/ \sqrt{Hz}
	f = 1kHz		-	0.6	2.5	pA/ \sqrt{Hz}
Broadband Noise Voltage	f = DC To 30kHz	25	-	0.870	-	μ V _{RMS}
POWER SUPPLY CHARACTERISTICS						
Supply Current		Full	-	4	7	mA
Power Supply Rejection Ratio	$\Delta V_S = \pm 5V$	Full	80	100	-	dB

NOTES:

- Output current is measured with $V_{OUT} = \pm 15V$ with $V_{SUPPLY} = \pm 18V$.
- Full power bandwidth is guaranteed by equation: Full power bandwidth = $\frac{\text{Slew Rate}}{2\pi V_{PEAK}}$, $V_{PEAK} = 10V$.
- Refer to Test Circuits section of the data sheet.
- Settling time is measured to 0.01% of final value for a 10V output step, and $A_V = -1$.
- The limits for these parameters are guaranteed based on lab characterization, and reflect lot-to-lot variation.

Test Circuits and Waveforms

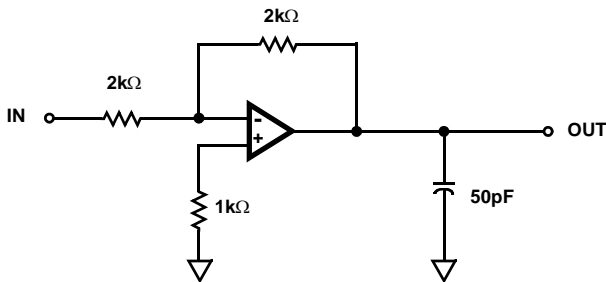

FIGURE 1. LARGE SIGNAL RESPONSE CIRCUIT

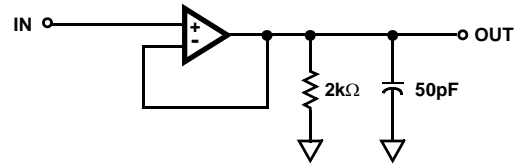
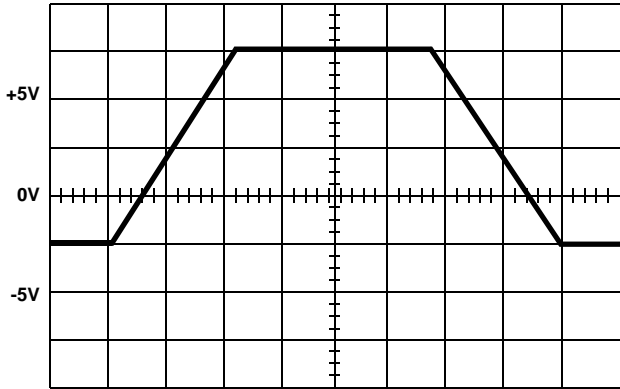

FIGURE 2. SMALL SIGNAL RESPONSE CIRCUIT

Test Circuits and Waveforms (Continued)



Ch. 1 = 2.5V/Div.
Timebase = 1.00µs/Div.

FIGURE 3. LARGE SIGNAL TRANSIENT RESPONSE

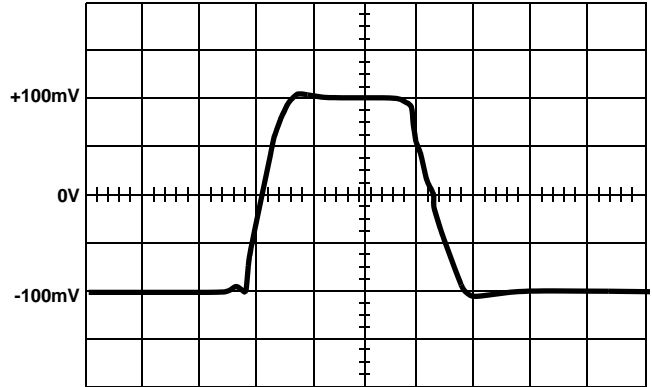

Ch. 1 = 50mV/Div.
Timebase = 100ns/Div.

FIGURE 4. SMALL SIGNAL TRANSIENT RESPONSE

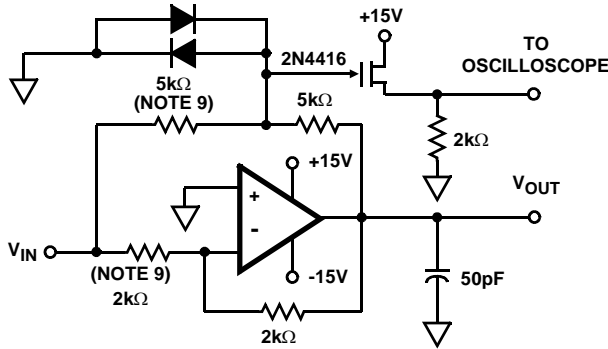

NOTES:

- 8. $A_V = -1$.
- 9. Feedback and summing resistors should be 0.1% matched.
- 10. Clipping diodes are optional, HP5082-2810 recommended.

FIGURE 5. SETTLING TIME CIRCUIT

Application Information

Operation At ±5V Supply

The HA-5101 performs well at $V_S = \pm 5V$ exhibiting typical characteristics as listed below:

I_{CC}	3.7mA
V_{IO}	0.5mV
I_{BIAS}	56nA
A_{VOL} ($V_O = \pm 3V$)	106kV/V
V_{OUT}	3.7V
I_{OUT}	13mA
CMRR ($\Delta V_{CM} = \pm 2.5V$)	90dB
PSRR ($\Delta V_S = 0.5V$)	90dB
Unity Gain Bandwidth	10MHz
Slew Rate	7V/µs

Offset Adjustment

The following is the recommended V_{IO} adjust configuration:

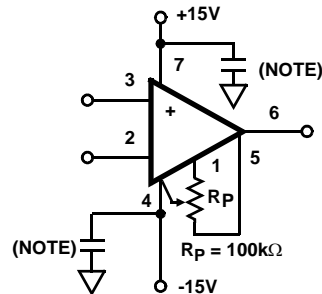

NOTE: Proper decoupling is always recommended, 0.1µF high quality capacitor should be at or very near the device's supply pins.

Input Protection

The HA-5101 has built-in back-to-back protection diodes which will limit the differential input voltage to approximately

7V. If the 5101 will be used in conditions where that voltage may be exceeded, then current limiting resistors must be used. No more than 25mA should be allowed to flow in the HA-5101's input.

Comparator Circuit

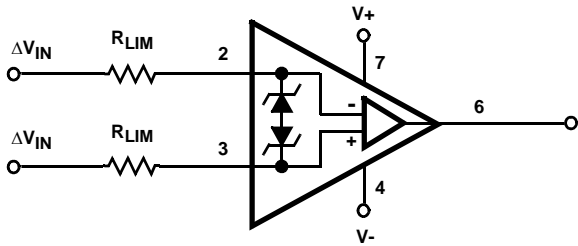

Choose R_{LIM} Such That: $\frac{(\Delta V_{INMAX} - 7V)}{25mA} \leq 2R_{LIM}$

Output Saturation

When an op amp is overdriven, output devices can saturate and sometimes take a long time to recover. Saturation can be avoided (sometimes) by using circuits such as:

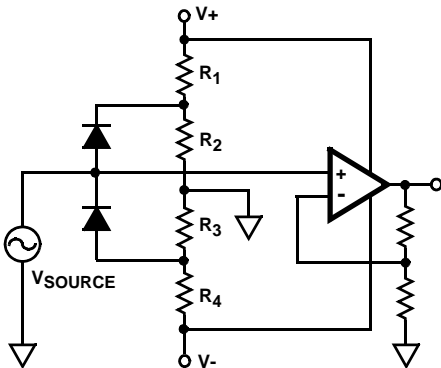

Typical Performance Curves

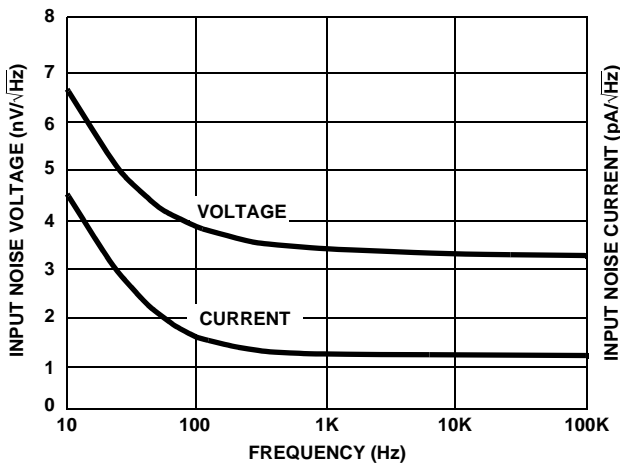
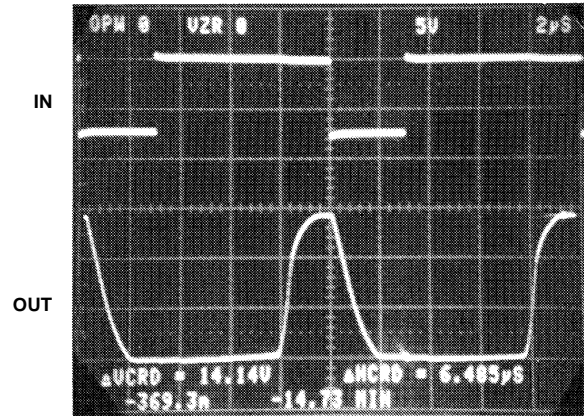

FIGURE 6. NOISE SPECTRUM

If saturation cannot be avoided the HA-5101 recovers from a 25% overdrive in about 6.5μs (see photos).



Top: Input
Bottom: Output, 5V/Div., 2μs/Div.
Output is overdriven negative and recovers in 6μs.

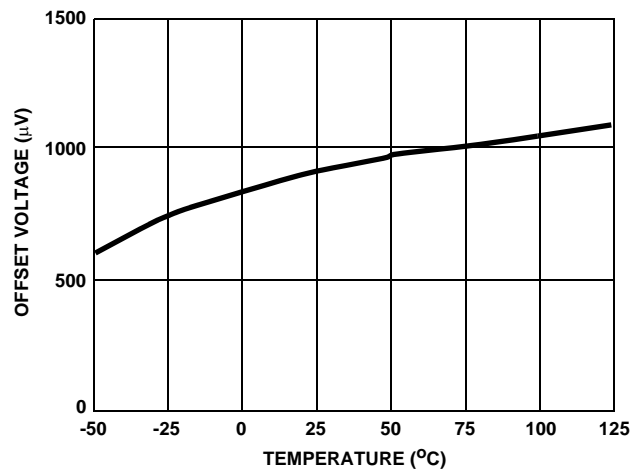
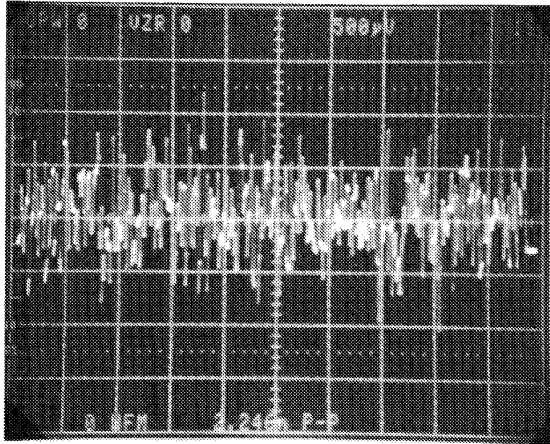
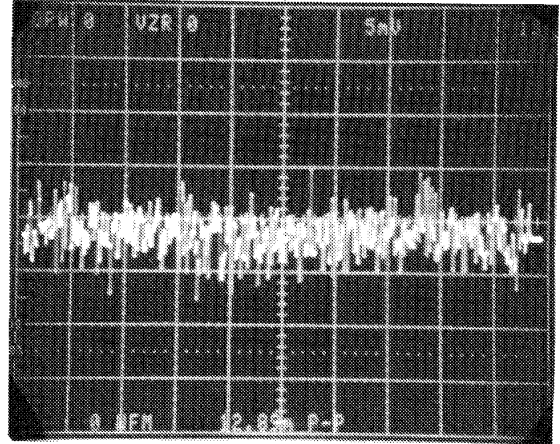

FIGURE 7. OFFSET VOLTAGE vs TEMPERATURE

Typical Performance Curves (Continued)



$A_V = 25000$, $V_S = \pm 15V$ (2.25µV_{p,p} RTO)
PEAK-TO-PEAK NOISE 0.1Hz TO 10Hz



$A_V = 25000$, $V_S = \pm 15V$ (12.89mV_{p,p} RTO)
PEAK-TO-PEAK TOTAL NOISE 0.1Hz TO 1MHz

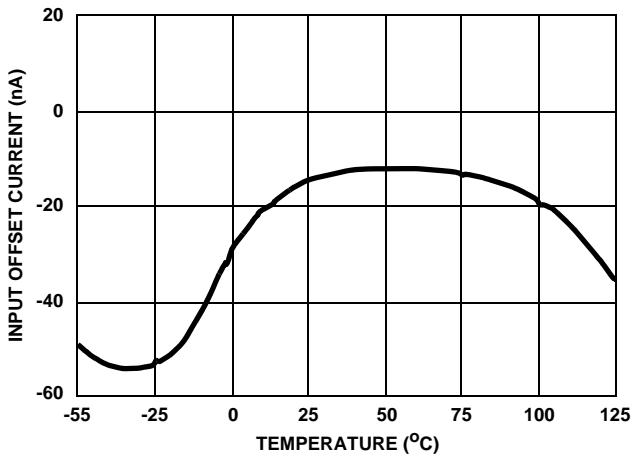

FIGURE 8. INPUT OFFSET CURRENT vs TEMPERATURE

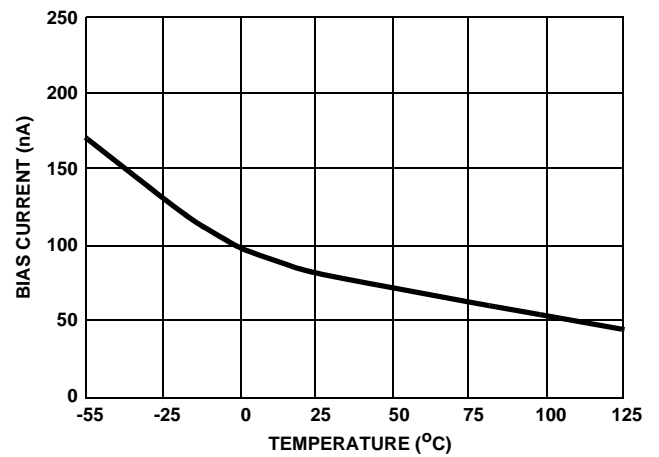

FIGURE 9. INPUT BIAS CURRENT vs TEMPERATURE

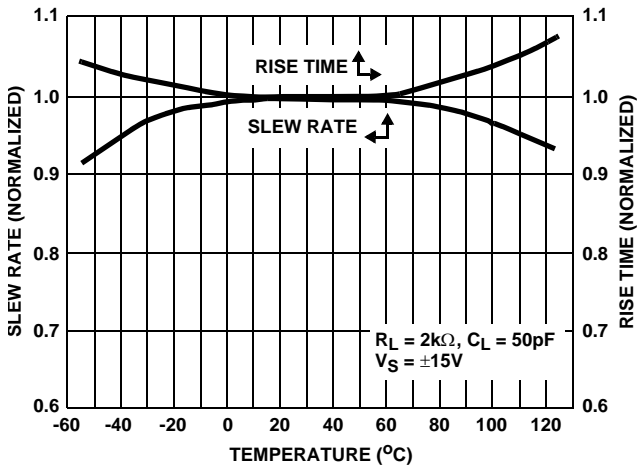

FIGURE 10. SLEW RATE/RISE TIME vs TEMPERATURE

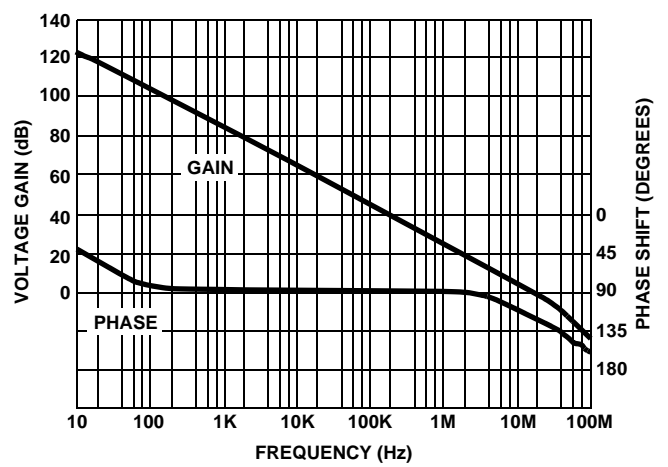

FIGURE 11. OPEN-LOOP GAIN/PHASE vs FREQUENCY

Typical Performance Curves (Continued)

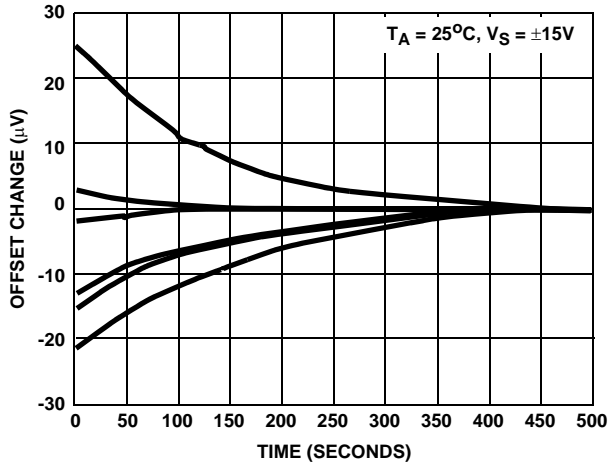

FIGURE 12. INPUT OFFSET WARMUP DRIFT vs TIME (NORMALIZED TO ZERO FINAL VALUE) (SIX REPRESENTATIVE UNITS)

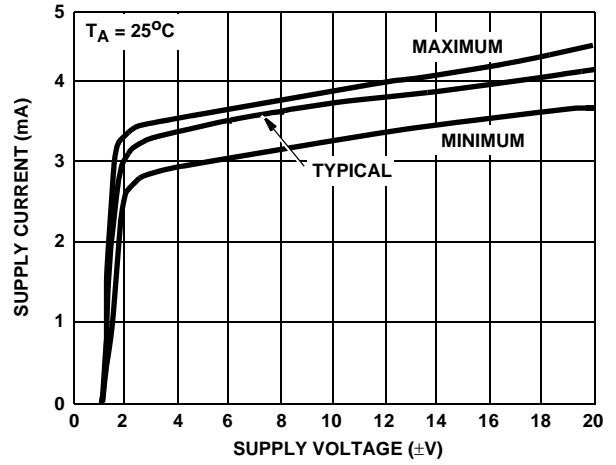

FIGURE 13. SUPPLY CURRENT vs SUPPLY VOLTAGE

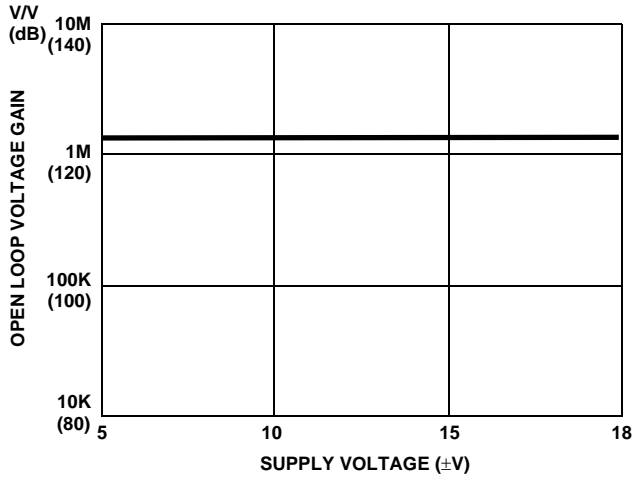

FIGURE 14. DC OPEN-LOOP VOLTAGE GAIN vs SUPPLY VOLTAGE

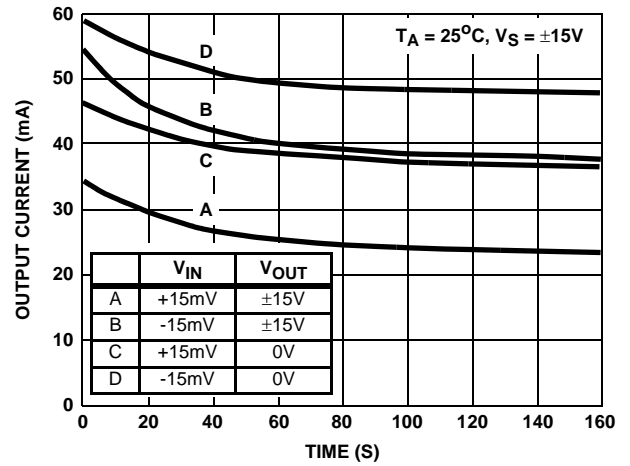

FIGURE 15. SHORT CIRCUIT CURRENT vs TIME

Typical Performance Curves (Continued)

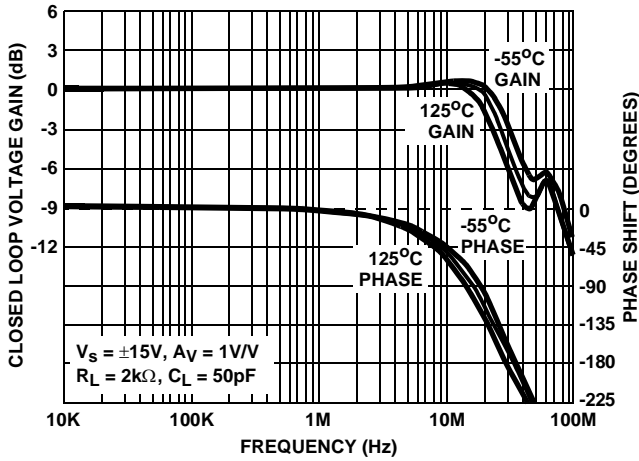

FIGURE 16. FREQUENCY RESPONSE

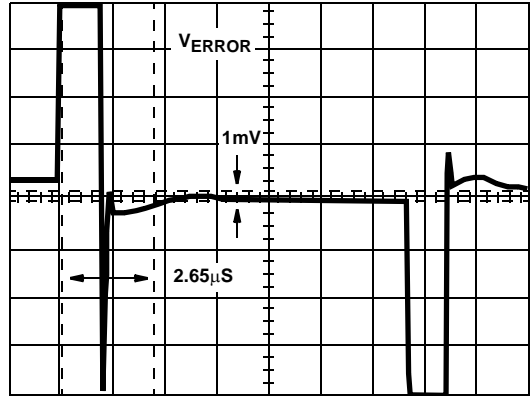

FIGURE 17. SETTLING WAVEFORM 1.5μs/DIV.

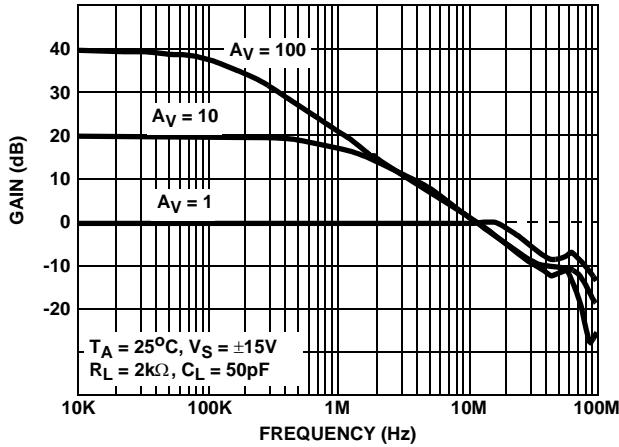

FIGURE 18. CLOSED-LOOP GAIN vs FREQUENCY

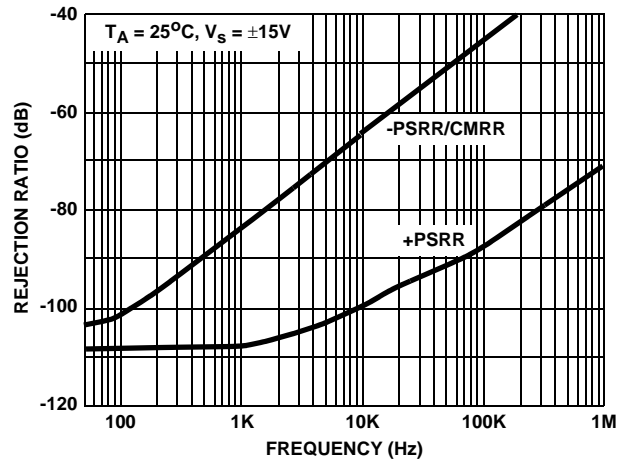

FIGURE 19. REJECTION RATIOS vs FREQUENCY

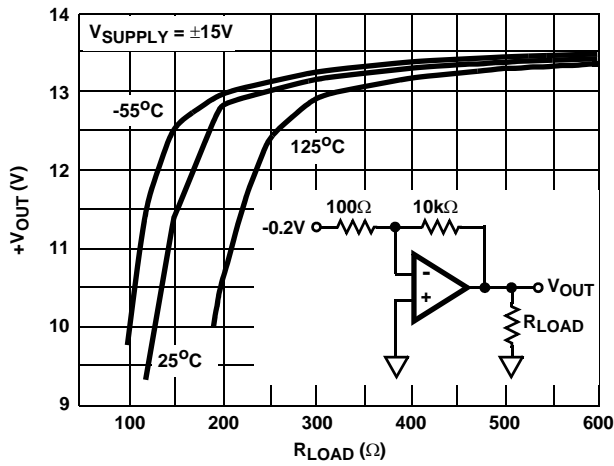

FIGURE 20. +V_{OUT} vs R_L

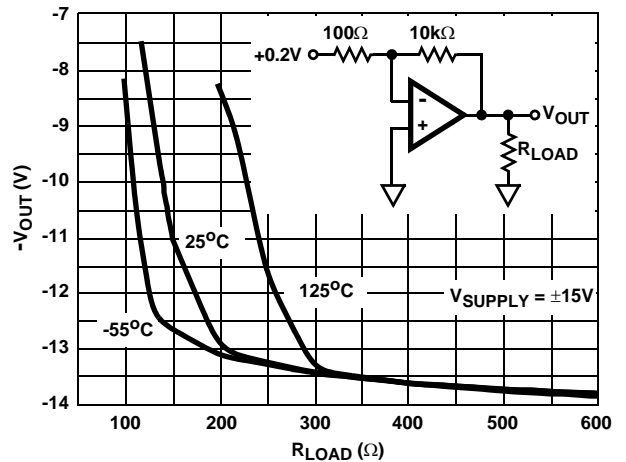

FIGURE 21. -V_{OUT} vs R_L

Die Characteristics

SUBSTRATE POTENTIAL (Powered Up): V-

TRANSISTOR COUNT: 54

PROCESS: Bipolar Dielectric Isolation

Metallization Mask Layout

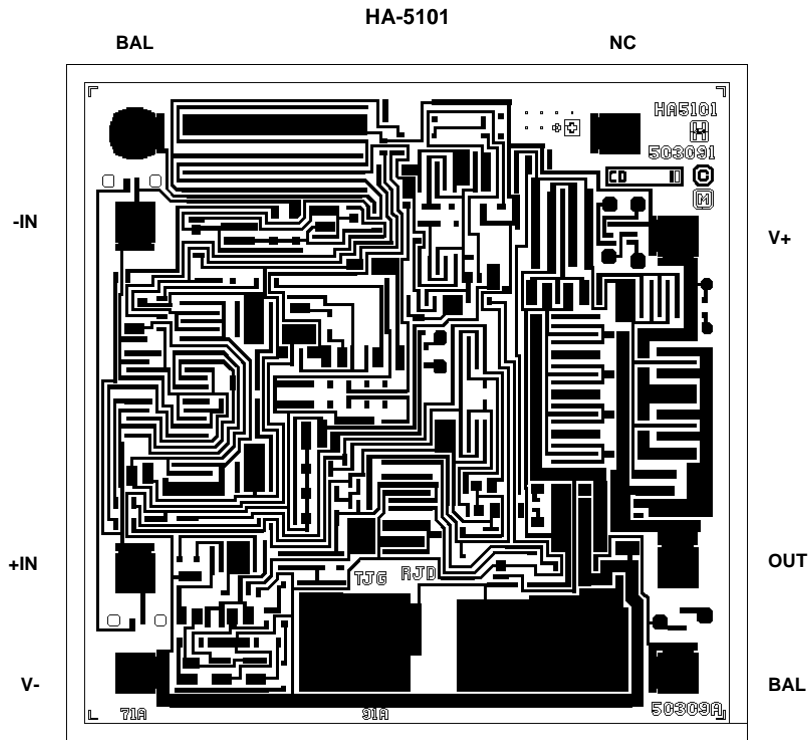

All Intersil U.S. products are manufactured, assembled and tested utilizing ISO9000 quality systems.

Intersil Corporation's quality certifications can be viewed at www.intersil.com/design/quality

Intersil products are sold by description only. Intersil Corporation reserves the right to make changes in circuit design, software and/or specifications at any time without notice. Accordingly, the reader is cautioned to verify that data sheets are current before placing orders. Information furnished by Intersil is believed to be accurate and reliable. However, no responsibility is assumed by Intersil or its subsidiaries for its use; nor for any infringements of patents or other rights of third parties which may result from its use. No license is granted by implication or otherwise under any patent or patent rights of Intersil or its subsidiaries.

For information regarding Intersil Corporation and its products, see www.intersil.com